

NEWDOSE ND
TYPE MOTOR DRIVEN METERING PUMP

NDWS/L ND1000 HND SERIES OPERATION MANUAL

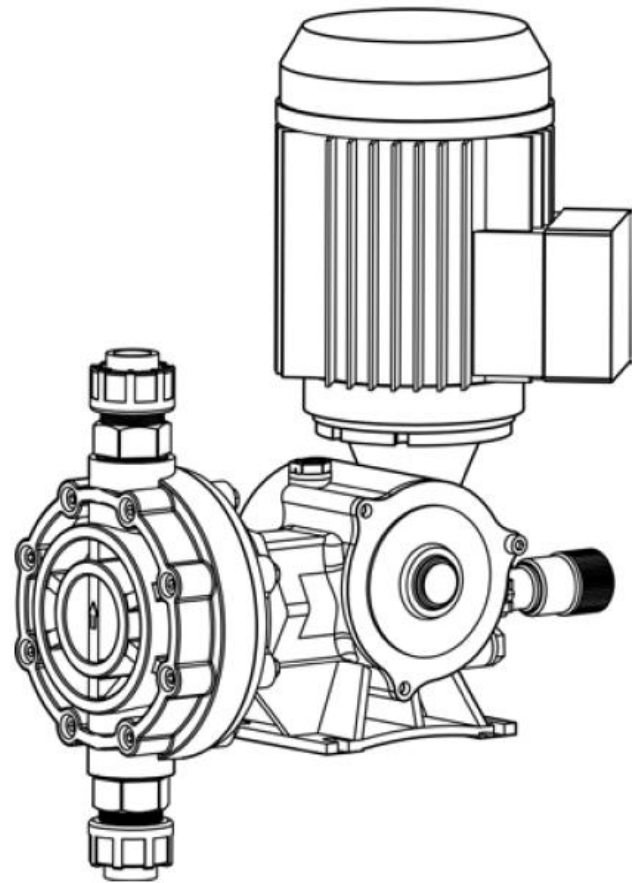

BEIJING ARK ELECTRIC & MECHANICAL CO., LTD.

Table of contents

1. Overview	1
2. Installation	2
2.1 Warning	2
2.2 Unpacking	3
2.3 Placement of Pump	3
2.4 General Pipe Conditions	4
2.5 Accessories	6
2.6 Electrical Connection	7
3. Operation.	
3.1 Check before Start-Up	7
3.2 Start-Up	8
3.3 Regulation of Pump Flow Rate	8
3.4 Calibration of Flow Rate	8
4. Stop	
4.1 Maintenance	9
4.2 Routine Maintenance Procedures	10
5. Guarantee Period and Coverage	10
6. Common Faults and Treatment Methods	11
7. Disassembly and Assembly Of Some Wearing Parts	
7.1 Pump Head Installation Drawing	12
7.2 Check Valve Installation Drawing	13
7.3 Stroke Length Adjustment Drawing	13
7.4 Procedure for Replacing Diaphragm Assembly	13
7.5 Replace Oil Seal	15

Safety warning

- ★ Carefully read the operating instructions before installation and using.
- ★ The installation of pumps and electrical equipment must follow the standards and specifications of the country where they are located.
- ★ Good grounding must be done during installation and using.
- ★ If the pump fails or is damaged, it must be repaired by authorized personnel and original accessories must be used, otherwise it will affect the safe use of the pump.
- ★ The maintenance of the metering pump's internal structure must be carried out by personnel with professional qualifications and authorized by the manufacturer. Therefore, all responsibilities arising therefrom shall be borne by the user.
- ★ Before carrying out maintenance or cleaning operations, the pump must use protective equipment, turn off the pump switch, and disconnect the pump power supply from the main power supply.
- ★ Avoid using pumps where the ambient temperature exceeds - 10~45°C or where pumps and pipes are directly exposed to sunlight.
- ★ Do not use metering pump in an environment outside the power supply range specified on the nameplate, otherwise it will cause damage to the pump or cause fire.
- ★ It is forbidden to pull, damage, or change wires, which may cause damage to the pump or cause fire.

Note: If there are any technical changes to this instruction manual, no further notice will be given.

1. Overview

Metering pump is a special volumetric pump used to deliver corrosive and non-corrosive liquids. Metering pump is also called dosing pump or proportional pump, which belongs to reciprocating positive displacement pump. The flow rate can be adjusted continuously within the range of 0~100 %, and is used for precise metering of dosing liquid. Its stability accuracy does not exceed 1 %. With the continuous development of modern industry towards automatic operation and remote automatic control, it is especially important that metering pumps have strong matching ability and adapt to a wide range of media (liquid) functions. The structural design of the E-type metering pump fully considers different working environments and is widely used in environmental protection water treatment industries such as petrochemical industry, natural gas exploitation, oil refining, thermal power plant, industrial and mining (boiler), food, pharmacy, scientific research, printing and dyeing, paper making, etc.

This manual introduces the correct installation, operation, maintenance and troubleshooting methods of the NDWS/L、HND、ND1000 series metering pump. If we can correctly use and maintain the pump, we can improve its stability and service life and give full play to its efficiency and service life.

Warnings:



The metering pump needs grease or lubricating oil to transfer energy, and the new machine drive unit contains the lubricant attached to the original factory. Do not use other lubricants to prevent the efficiency and life of the transmission unit from decreasing.



Regularly check the lubricant level of the tank body, and judge whether the lubricant needs to be added from the oil window on the metering pump tank body compared with the position of the oil line and the oil level.

Working principle of ND series mechanical diaphragm metering pump

The motor drives the helical gear reduction box connected with the main shaft to form a reduction mechanical structure, the bearing is on the eccentric shaft, the eccentric shaft rotates under the drive of the output shaft of the reduction box, the bearing performs eccentric motion on the eccentric circle of the eccentric shaft, the generated eccentric distance is converted into linear motion of the push rod, and the push rod drives the diaphragm to do linear reciprocating motion with the cooperation of the restoring force of the spring. A reciprocating cycle is called a stroke, the reciprocating distance is called the stroke length, and the number of reciprocating cycles per minute is called the stroke frequency.

When the push rod pulls the diaphragm to move backward, the volume between the diaphragm and the pump head increases to generate negative pressure, the one-way valve of the suction pipeline opens, and the medium in the inlet pipeline enters the cavity of the pump head. When the suction stroke ends, the diaphragm movement stops instantly, the pressure in the pump head is balanced with the pressure in the inlet pipe, and the one-way valve of the suction port is reset. During the discharge stroke, the diaphragm connected with the slide bar moves forward, and the pressure in the pump head immediately rises. When the pump head pressure is higher than the outlet pressure, the outlet check valve is opened, and the medium in the pump head enters the discharge line. When the discharge stroke ends, the diaphragm movement stops again, the pressure in the pump head is equal to the outlet pressure, and the outlet check valve resets, and then enters the next cycle, thus forming the transmission of liquid in the form of pulses. Rotate the stroke adjusting rod, which rotates to feed or move away from the box body, so that the distance traveled by the push rod is correspondingly reduced or increased, thereby adjusting the stroke size and finally achieve the purpose of changing the stroke adjusting flow rate.



The scale on the stroke adjusting lever shows the percentage of the current stroke to the full stroke, which can be approximated as the percentage of the current flow to the full scale at the current pressure.

2. Installation

2.1 Safety warning

- ◆ When installing or maintaining the pump, the power supply must be cut off, warning signs should be hung at the switch to relieve the pressure of the system and close the inlet and outlet valves connected to the pump and the system so as not to cause casualties and property losses due to misoperation.
- ◆ In the process of operation, when a dangerous signal or abnormal situation is found, the operation is immediately terminated.
- ◆ Using the pump with the selected working range under other range or working condition will result in personal injury or damage to the pump. Use the pump strictly according to the pump instructions and scope of use.
- ◆ It is strictly prohibited to disassemble or modify the pump or use accessories that are not approved by the manufacturer, otherwise the user will be responsible for the resulting personnel injury and damage to the pump.
- ◆ If the measured medium is dangerous or unknown liquid, the operator should wear protective equipment (safety glasses, gloves, protective clothing, etc.) when operating and maintaining the metering pump.

- ◆ Users should regularly check whether the metering pump works normally, check whether all seals and screws are tightly connected, and take corresponding preventive measures to prevent the medium from causing injury to the operator.

Attentions:

- ⚠ Thoroughly flush and clean the overflowing part before disassembly.
- ⚠ Metering pump metering medium must be in a state of aggregation, paying attention to the freezing point and boiling point of the medium.
- ⚠ If the metering liquid leaks, cut off the power supply immediately, find out the cause of the leakage, and clean the residual liquid on all metal parts that contact the liquid so as to prevent the medium from entering the pump body or corroding the fasteners.
- ⚠ Do not operate the metering pump with the outlet pipeline blocked or the outlet shut-off door closed, otherwise it will cause irreversible damage to the metering pump.

2.2 Unpacking

- ⚠ When the customer receives the pump, carefully check the transportation package and confirm that no damage occurred during transportation. If any damage occurred during transportation, the customer shall immediately notify the carrier and the shipper and claim compensation.
- ⚠ Open the package and confirm that all items including accessories are in good condition, the quantity is correct, and check with the packing list.

2.3 Placement of pump

- ◆ Metering pump shall be installed in a well ventilated, dust-free and dry place.
- ◆ Use bolts to horizontally fix the metering pump base on the worktable to prevent the metering pump from falling. The worktable must be at a certain height from the ground so that the pipes connected to the inlet valve have sufficient installation space to ensure that the inlet and outlet of the pump are not inclined vertically to the ground.
- ⚠ The worktable should be firm and vibration-resistant, and reserve enough space around it to facilitate maintenance and adjustment of the pump.
- ◆ A container should be prepared at the lower part of the pump head to collect the media or lubricating oil leaked after the diaphragm or oil seal breaks. This work is especially important when handling some harmful media.
- ◆ This metering pump is not suitable for work or storage in outdoor environment without any protective measures. Outdoor installation should be covered by canopy.

- ◆ Typical installation diagram (See figure 1)

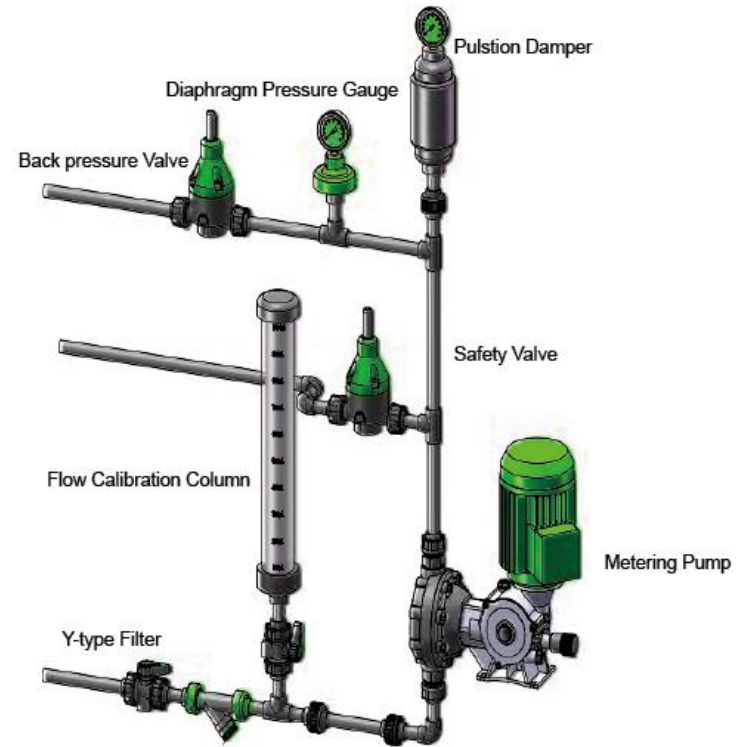

2.4 General piping conditions

- ◆ The pipeline should be arranged in such a way as to avoid the generation of air segments. Therefore, it is suggested that the pipeline should be inclined so that such problems can be well solved.
- ◆ The pipeline must meet the requirement of being able to bear the highest pressure.
- ◆ When the pipeline is connected with the pump head, the pump head should not bear additional load to avoid stress and vibration. Therefore, the pipeline should be supported and fixed when installing the pipeline.
- ◆ Before connecting the pipelines, burrs, sharp edges and residues inside the pipelines should be removed and the pipelines should be cleaned.
- ◆ When transporting media containing suspended solids or sediment, valves should be installed at elbows so that pipelines can be cleaned without disassembly; Or the elbow is changed into a four-way pipe with pipe plugging, so that the pipeline can be washed without being disassembled.
- ◆ Install tee and stop valves near the inlet and outlet pipelines of the pump head so that the pump head can be cleaned without disassembling the pipelines.

2.4.1 Suction pipeline



During the suction stroke, the pressure in the pump head must be higher than the vapor pressure of the material. If the liquid pressure is lower than its vaporization pressure, cavitation will occur, which will affect the performance of the pump.

- ◆ The liquid suction end of the pump should be lower than the lowest liquid level of the liquid storage tank so that the liquid suction end of the pump can be directly filled with liquid medicine. In order to reduce the pipeline loss, the pump should be installed as close as possible to the dosing cabinet.
- ◆ The connection of the suction pipe must be closely connected to prevent air from being sucked in. If air is sucked in, it will cause poor discharge or unstable pump operation.
- ◆ Avoid negative pressure suction conditions of the equipment that will affect the measurement accuracy. The maximum suction height of the water column is 2m.
- ◆ Metal or hard plastic pipes with smooth inner wall should be used for suction pipes, and care should be taken not to have omega - shaped pipes. Because good pipelines have smooth inner walls and large radius bends are used to reduce flow friction losses, the bends at the top of the suction pipeline will lead to inexhaustible exhaust gas and the accumulation of air segments, air segments and bubbles will lead to insufficient suction. Therefore, it should be avoided these problems as far as possible.
- ◆ Filters should be used for suction pipes to prevent impurities such as particles and materials from entering the pump, causing blockage and wear of the over-flow parts. Filters should be checked frequently for blockage and cleaned in time.
- ◆ The suction line is as short and straight as possible and must be absolutely airtight to ensure accurate flow. After the pipeline is installed, use air and soap solution to test whether the pipeline leaks or not.
- ◆ The diameter of the suction line should not be less than the inlet size of the pump head so as to avoid liquid shortage of the pump.
- ◆ When delivering viscous liquid, to reduce the flow loss of viscous liquid, the inlet pipeline should be properly enlarged. If not sure, please contact our company to ensure the necessary pipe size.

2.4.2 Discharge pipe

- ◆ Pipeline installation should ensure sufficient space to avoid excessive pressure loss at the outlet of the pump. The maximum working pressure at the pump head outlet shall not be higher than the maximum rated pressure indicated on the pump nameplate. When the pressure difference between the inlet and outlet of the pump is less than 1 bar, in order to ensure the measurement accuracy, a back pressure valve needs to be installed to artificially establish the outlet pressure.
- ◆ When one pump is used to add medicine to multiple injection points, there will be pressure difference between the injection points. Although the pressure difference is

very small, it will cause the flow rate at the lowest pressure injection point to be much larger than that at other injection points, thus unable to achieve the required measurement accuracy. Therefore, it is recommended to use a pump separately for each injection point.

2.5 Accessories

The pump does not contain accessories.

2.5.1 Back pressure valve

When the measuring pump works at a low pressure, it is recommended to install a backpressure valve at the outlet of the metering pump to reduce the siphon trend. Normally, the installation position of the backpressure valve should be close to the outlet of the pump. However, for pumps with large flow rate and long and thin outlet pipes, the back pressure valve should be installed close to the filling point to reduce the siphon tendency. If the pulsation damper is installed at the same time, the backpressure valve should be installed behind the pulsation damper.

2.5.2 Impulse damper

Normally, the pulse damper and the backpressure valve should be used simultaneously in the outlet line to absorb the peak flow between the pump and the backpressure valve. If there is no pulse damper, the backpressure valve will open or close rapidly as each pump stroke progresses. If there is a pulse damper, the back pressure valve works in the half-open and half-closed positions, which can reduce the wear speed of the back pressure valve. The greater advantage of the pulse damper in the outlet pipeline is to limit the flow and pressure changes of the metering pump, change the larger pulse caused by the reciprocating motion, and smooth the linearity of the flow, so that the pressure can be controlled within a stable range, the working performance of the pump can be improved, and the performance of the pump can be guaranteed without increasing the pipe diameter.

2.5.3 Safety valve and exhaust valve

- ◆ In order to safely and effectively control the flow rate and pressure of the system, a safety valve is installed on the liquid outlet pipeline between the pump and the nearest shut-off valve, so that when the motor generates a large discharge pressure before the thermal protection element cuts off the control circuit, the pump, pipeline and equipment can be prevented from being damaged due to blockage of the outlet pipeline, and the pump can also be prevented from being damaged due to accidental closing of the valve.
- ◆ The safety valve must be installed at the outlet of the metering pump, close to the metering pump, so as to work normally. The outlet pipe of the safety valve returns to the liquid suction tank or connects to the drain pipe, but its end must be visible (or installed with a liquid flow indicator) so as to detect the leakage of the safety valve.

- ◆ In order to help the metering pump start-up, it is recommended to install an exhaust valve at the outlet of the metering pump.

2.5.4 Globe valve

Globe valves shall be installed in both the suction pipe and the discharge pipe of the pump, and the globe valve of the discharge pipe shall be located downstream of the safety valve of the inlet pipe.

2.6 Electrical connection

- ◆ Confirm whether the power supply is in conformity with the motor identification to prevent burning of the motor.
- ◆ The electrical protection of the motor must conform to the rated current of the motor.
- ◆ Connect the ground wire with the three live wires, start the motor to check the motor's steering. If it is inconsistent with the motor installation arrow, change the position of the two live wires at will to make its steering consistent with the motor installation arrow, i.e. the motor blades should rotate clockwise. If the motor rotates reversely, it will cause damage to the motor and the pump, and it is not covered by the warranty of the metering pump.

 After the metering pump is connected to the power supply, be sure to point out the manual metering pump to confirm the direction of rotation.

3. Operation

3.1 Check before start-up

- ◆ Check whether all the assembly bolts are firm, whether the pipeline is installed correctly, whether the outlet pipe valve is open, and whether the oil drain plug is tightened or not. Remove the oil filling plug and fill the mechanical oil installed in the packing box. The injected oil shall be subject to the oil sight glass (-winter lubricating oil shall be replaced below 0 ℃).
- ◆ Inspection of motor and electrical wiring: the voltage shall be in accordance with the calibration requirements on the motor nameplate, and the motor shall rotate in the direction of arrow.

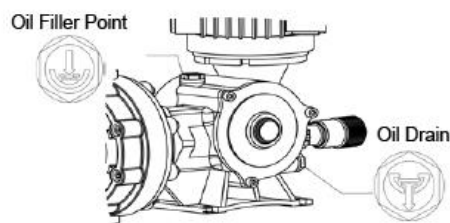



Figure 2

3.2 Start up

- ◆ Open the globe valve of the inlet pipe and all valves on the outlet pipe. It is best to allow the inlet pipe and pump head to fill themselves with materials.
- ◆ Turn the stroke adjustment, adjust the handwheel to the " 0 %" position, jog the motor to start the metering pump, identify whether there is abnormal noise in the pump body, and allow the metering pump to run for 5 minutes in a state where the stroke length is zero.

 This operation is very important for the occasions where the metering pump is used in cold environment, because after no-load operation, the lubricating oil in the metering pump box and the reducer box can gradually increase with the operating temperature, so that the lubricating effect can be achieved; otherwise, gear wear caused by poor lubrication will occur.

- ◆ If there is no abnormal phenomenon, turn the adjusting handwheel, slowly adjust the flow rate to 30 %, and exhaust the air in the pipeline to ensure that there is no air in the pipeline.
- ◆ When the pressure value of the pressure gauge is close to the predetermined pressure, slowly adjust the backpressure valve until the required (not exceeding the rated pressure) pressure is reached. Keep the pump in this state, run for about 20 seconds, and then slowly turn the adjusting handwheel. At the same time, slowly adjust the back pressure valve to keep the pressure of the pressure gauge at the required pressure.
- ◆ Check whether the discharge quantity of metering pumps meets the nameplate label.

 The nameplate data provided by the Newdos metering pump is measured by clean water at normal temperature, which will be different due to the influence of other conditions such as actual different pipelines and liquids.

- ◆ Please inflate the air bag or diaphragm regularly. If air chamber type pulsation damper is used, the liquid in the damper must be emptied regularly to ensure the normal operation of the pulsation damper.

3.3 Regulation of pump flow rate

The flow rate of the pump is adjusted by rotating the adjusting handle so as to change the bottom dead center position of the push rod. Adjust the stroke length of the push rod; the smaller the stroke length, the smaller the flow rate; the longer the stroke length, the longer the flow rate.

3.4 Calibration of flow rate

After the first 12 hours of pump operation, the pump should be calibrated and tested to find out the flow parameters under specific operating conditions. Calibration is usually carried out at the ratio of 100 %, 50 % and 20 % of the three strokes, which can

measure the precise flow rate of the pump in the whole range of adjustment under the current working environment.

- ◆ By monitoring the change of the liquid level in a calibration container, the flow rate of the pump can be calculated. It is suggested that this method should be used to calibrate dangerous liquids.
- ◆ The output liquid is collected and measured at the outlet of the pump, and the current flow parameter of the pump can be obtained by regular measurement. However, it is suggested to establish outlet pressure at the liquid discharge point so that the pump can work accurately.

 It is recommended that this method should not be used to calibrate the flow rate in general, because this makes the operator directly face the dangerous liquid and may lead to accidents. In addition, when we use this method to calibrate the flow rate, the pump is likely to be in a self-flowing state, and the calibrated data will be larger than the actual value.

4. Stop

First, let the outlet backpressure valve fully opened, the discharge pressure is reduced to normal pressure, and the power supply is cut off to stop the motor from running.

 When the pump is not used for a long time (more than one week) and needs to be started again, the stroke length must be adjusted to 0 %, and the pump can be used normally after running for several minutes under no-load conditions.

4.1 Maintenance of pump

Preventive maintenance

- ◆ Lubricating oil: the newly activated pump will need to replace the lubricating oil of the cabinet after running for 800 hours, and will be replaced once every 3,000 hours or half a year later.
- ◆ Diaphragm: replace once every 5000 hours or every year;
- ◆ Oil seal: replace once a year;
- ◆ Others: replace the check valve ball, valve seat, gasket and "o" ring every 5000 hours. If transporting high viscosity or highly corrosive materials, it is necessary to increase the frequency of replacement of spare parts.

 Before performing any maintenance on the pump, the equipment shall be stopped, the system pressure shall be released, and the inlet and outlet valves connected to the system shall be closed. If any fault is found during operation, cut off the power supply immediately.

4.2 Routine maintenance procedures

 Regularly check whether the amount of lubricating oil is sufficient, whether there is leakage, and whether it is aging or not.

4.2.1 Check the sealing of mechanical parts

Check all parts connected to the box body for leakage. If leakage occurs, replace the sealing ring at the connection, such as motor mounting flange, stroke adjustment, transition section, box body oil window, oil outlet hole and other parts.

4.2.2 Check the flow rate of the pump

Through the calibration of the pump displacement, we can judge whether the pump is transporting materials normally.

If the pump displacement exceeds the range, we need to contact the manufacturer to carry out the corresponding maintenance work.

4.2.3 Leakage at the detection port

Check whether the liquid collected at the pump head inspection port is transported material or lubricating oil. If the inspection port leaks material transported by the pump, the diaphragm is cracked and the diaphragm needs to be replaced. If lubricating oil leaks from the inspection port, the oil seal is cracked and the oil seal needs to be replaced.

5. Guarantee period and coverage

- ◆ The warranty period is one year and the date is calculated from the time of delivery.
- ◆ Maintenance and replacement are paid services under the following circumstances:
 - ◆ Failure or damage occurring after the warranty period.
 - ◆ The nameplate is damaged or lost.
 - ◆ Failure or damage caused by improper use or storage.
 - ◆ Failure or damage caused by the use of unspecified parts or lubricants.
 - ◆ Failure or damage caused since the repair or modification has not been carried out according to our company's opinions or design requirements.
 - ◆ Failure or damage caused by force majeure events such as fire, earthquake or other disasters.
- ◆ Please note that we are not responsible for any failure or damage to the products manufactured according to the standards or design requirements required by the customer.
- ◆ The cause of the failure or damage shall be issued by our company's technical engineer.

6. Common faults and treatment methods

Item	Faults	Cause analysis	Exclusion methods
1	No liquid at all	Suction height is too high	Reduce installation height and elbow valve
		Suction pipe blocked	Cleaning and dredging suction pipe
		Air leakage from suction pipe	Compress or replace flange gasket
2	Insufficient flow	Local blockage of suction pipe	Cleaning and dredging suction pipe
		There is foreign matter in the one-way valve	Cleaning one-way valve
		The one-way valve is worn and the closure is lax.	Repair or replace one-way valve
		Diaphragm deformation	Replace diaphragm
		Insufficient number of revolutions	Check motor and voltage
		Suction too high	Suction should be controlled within 2m
		The viscosity of the liquid is high.	Replace pumps suitable for delivering high viscosity
3	Discharge pressure is unstable	There are crystals or sundries in the upper and lower check valves	Clean or replace the upper and lower check valves
		Drain leakage at pipe joint	Tighten the threads at the joint
4	Pipe vibration	Diaphragm deformation	Replace diaphragm
		The upper and lower check valves are worn or not tightly sealed.	Repair or replace one-way valve
		Unstable motor speed	Check motor and voltage
5	Leakage of transport medium	Diaphragm rupture	Replace diaphragm
		Diaphragm loosening	Tighten the diaphragm to compress the screws on the pump head

7. Disassembly and assembly of some wearing parts



When reassembling the one-way valve, confirm and carefully install it according to the correct illustration in the instruction manual. The wrong installation of the one-way valve will cause the following phenomena:

- ◆ Causing serious damage to the mechanical structure of the metering pump immediately
- ◆ There is a discharge of material
- ◆ Reverse infusion (from inlet line to outlet line)

7.1 Pump head installation drawing



The one-way valve is sealed by the sealing ring on the end face. After using the raw material tape (PTFE tape), it is easy to cause the sealing ring not to be fully compressed, and to cause leakage.

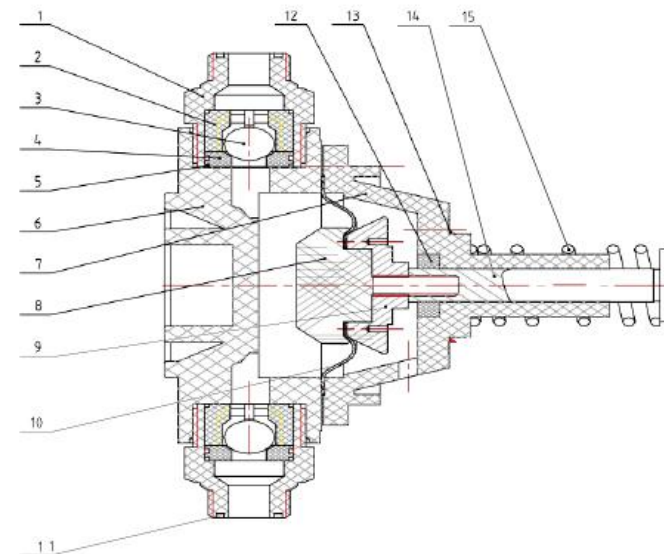

Figure 3

Item	Parts Name	Qty
15	Spring	1
14	Pusher	1
13	O-ring 50×1.8	1
12	NOG oil seal	1
11	O-ring 18×3.55	2
10	Diaphragm	1
9	Diaphragm protector	1
8	Fasten bolt for Diaphragm	1
7	Transition Connector	1
6	Pump Head	1
5	O-ring 25×1.8	4
4	Valve Seat	2
3	Valve Ball	2
2	Val Body	2
1	Valve Cover	2

7.2 Check Valve Installation Drawing



The one-way valve and pump head cannot be screwed too tightly, which may cause damage to the pump head.

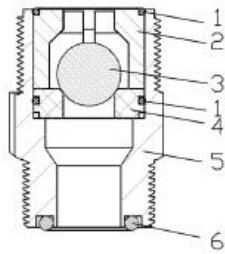

Suction Valve

Item	Parts Name
1	O-ring 25×1.8
2	Valve Body
3	Valve Ball
4	Valve Seat
5	Valve Cover
6	O-ring 18×3.55

Figure 4

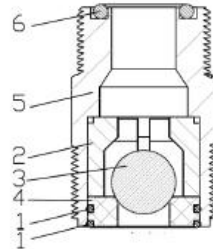

Injection Valve

7.3 Stroke Length Adjustment Drawing

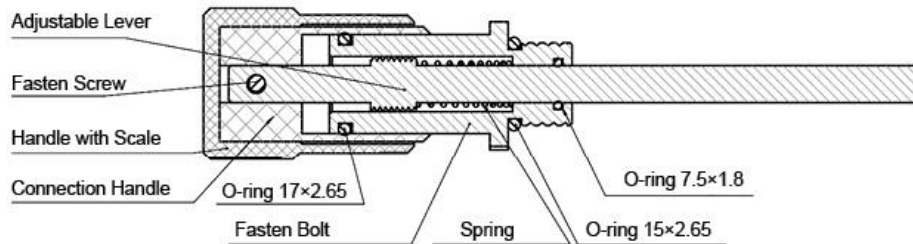

Figure 5

7.4 Procedure for replacing diaphragm assembly

- ◆ Cut off the power supply of metering pump, remove the pressure in the pipeline, and close the stop valve of the inlet and outlet pipeline.
- ◆ Loosen the nut connecting the upper and lower liquid outlet pipes of the metering pump, and it can be directly disassembled at the installation point under the condition that the operating environment is safe and dry.



If the installation point is too wet or the operation space is limited, please remove the metering pump from the installation position, clean up the liquid in the pump head, and wash it with clean water. This operation is especially important for the metering pump that delivers corrosive liquid.

- ◆ Remove the rubber block at the corresponding position on the pump head.
- ◆ Loosen the screws on the pump head in diagonal sequence. (See figure 6)
- ◆ Removing the pump head, save the pump head screws and nuts, turn the stroke adjusting rod to the 0 % position. At this time, the diaphragm assembly will be jacked up and separated from the over section. (See figure 7)

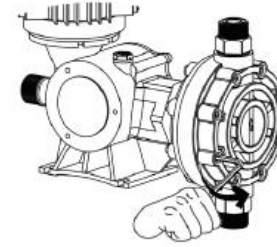

Figure 6

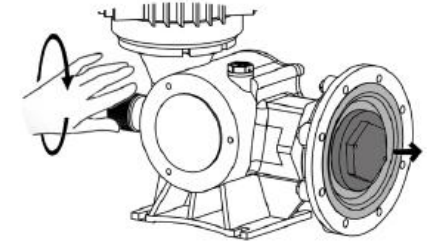

Figure 7

- ◆ Turn the diaphragm counterclockwise by hand or wrench, and the diaphragm will be loosened and separated from the push rod. (See figure 8)
- ◆ Clean the transition section, apply grease to the push rod, protect the metal parts from corrosion, and tighten the new diaphragm assembly clockwise. (See figure 9).

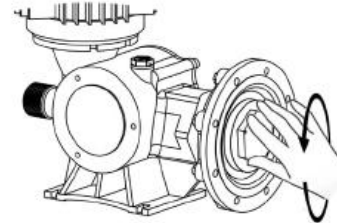

Figure 8

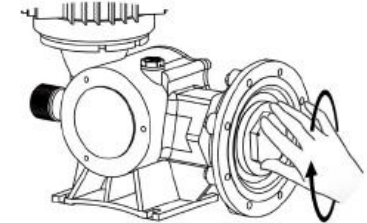

Figure 9

- ◆ After tightening, adjust the stroke adjustment knob to 100 %, fix the pump head with pump head screws, install the glue plug back, and complete the replacement.



When replacing the pump head, confirm whether the direction of the arrow on the pump head is consistent with the direction of water flow. Incorrect installation will cause irreversible damage to the pipe valve and metering pump.

7.5 Replace Oil Seal

- ◆ When figure 8 is finished according to the operation method of 7.4, it is necessary to turn the stroke adjustment knob to 100 %, and then use a wrench to diagonally remove the bolts on the transition section. (See figure 10).
- ◆ Before this operation, the lubricating oil in the metering pump box must be completely drained. Please refer to figure 2 for the location of the oil drain hole.

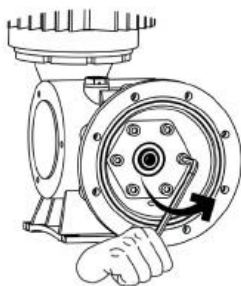

Figure 10

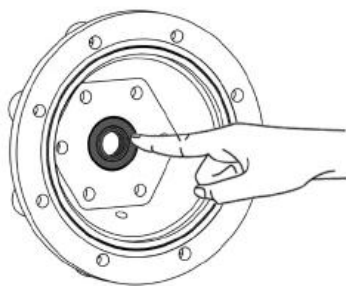

Figure 11

- ◆ Remove the transition section, save the push rod, spring and bolt, pry out the oil seal in the middle of the transition section, and then install the new oil seal. (See figure 11).
- ◆ After replacement, install the push rod, spring and transition section in sequence. (See figure 12).
- ◆ There is an air vent on the side of the transition section. This air vent must be on the bottom side during installation. Block and wrong position of the air vent may cause damage to metal parts on the back of the metering pump or oil leakage. Please confirm whether the installation direction is correct during installation. (See figure 13).

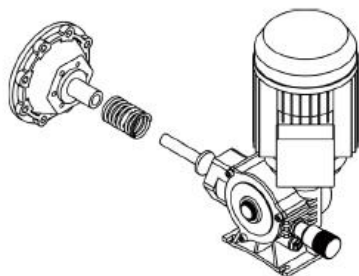

Figure 12

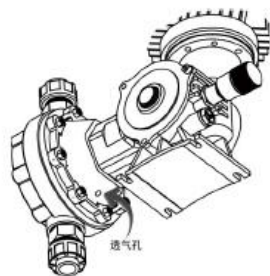

Figure 13

Maintenance Record Sheet

User Information

Company	Tel
Contacts	Fax
Address	Supplier

Metering Pump Failure

Model	Product code	Date of use	Date of failure	Fault problem description

Maintenance Record

Maintainer	Maintenance date	Maintenance content

Service Condition Of Metering Pump

Conveying liquid		Working environment		Installation condition	
Name		Temperature		Base material	<input type="checkbox"/> Steel frame <input type="checkbox"/> Plastic bucket <input type="checkbox"/> Concrete
Concentration		Humidity		Pipe connection	<input type="checkbox"/> Hose <input type="checkbox"/> Hard tube
Temperature		Vibration	<input type="checkbox"/> Yes <input type="checkbox"/> No	Installed in a closed box body	<input type="checkbox"/> Yes <input type="checkbox"/> No